



ENTERPRISE SYSTEMTM
FOR BRICK-TIE CHANNELS



www.enterprisesystem.co.uk

+ Product Range

1. [Enterprise System Product Brochure](#)



CONTENTS

Main Components	4
Bi-metal [™] Composite Panel Range	6
Bi-metal [™] Masonry Range	7
Tie Lengths	8
25/14 Channel	9
Application Guide	10-13
Technical Data by Substrate Type	14
Other Fasteners	15-16
Laboratory Services	17



THE ENTERPRISE

BRICK-TIE CHANNEL SYSTEM.

ONE SIZE DOES NOT FIT ALL.

On Type 1 projects, fixing spacings should never be assumed.

They must be determined by **WIND LOADING CALCULATIONS** and the elevation of the building.

We'll calculate the correct spacing, 225 mm or 337.5 mm.

FREE OF CHARGE

The Enterprise Difference

Does your current provider match this support? With Evolution, engineering expertise, compliance and long-term safety come as standard.

Our engineers are specialists in guiding technical submissions through the BSA Gateways. Get in touch today for expert support

www.enterprisesystem.co.uk



WHAT WE OFFER:

Free Wind Load Analysis -

Send our Technical Team your external wall details and elevations, and we'll conduct the analysis.

Full Specification / Re-Specification -

We'll issue a tailored specification for fixings, ties, sleeves, and channel, confirming the correct spacings required.

Substantial Cost Savings -

Precise calculations mean no over-specification, helping to reduce unnecessary project costs.

Free U-Value Calculations -

Ensuring compliance with energy performance requirements,

The Main Components Of The Enterprise System.

GOLDEN THREAD READY.®

Our new Enterprise Brick-tie channel system™ is designed to be golden thread ready, aligning with best practices in modern construction.

This means that our system is fully compliant with the highest standards of transparency, traceability, and accountability throughout its life-cycle.

By integrating the Enterprise Brick-tie channel system™ into your projects, you ensure a seamless flow of information and a robust, reliable construction process that meets the rigorous demands of today's building industry.

60 YEAR WARRANTY.

Our new Enterprise Brick-tie channel system™ comes with an impressive 60-year warranty, underscoring our confidence in its durability and performance. This extensive warranty ensures long-term reliability and peace of mind, reflecting our commitment to delivering high-quality, dependable products.

PROJECT-SPECIFIC TEST.

With every order of our new Enterprise Brick-tie channel system™, you will receive a test report from our UKAS-accredited laboratory.

This comprehensive documentation ensures that you have verifiable evidence of the system's performance and reliability, demonstrating our commitment to quality and transparency.



Laboratory Testing

Every Enterprise Brick-tie channel system™ project benefits from laboratory validation within our UKAS-accredited testing facility.

Our risk-based methodology ensures that the scope and depth of testing are proportionate to the project classification and regulatory requirements, whilst maintaining rigorous quality assurance standards.

All High-Risk Buildings (HRBs) typically receive comprehensive laboratory testing as standard - a complimentary service designed to provide additional assurance through bespoke test suites conducted within our UKAS-accredited testing facility.

This targeted testing regime validates material performance characteristics and installation integrity, offering enhanced confidence in long-term system reliability.

For projects where our risk assessment indicates laboratory testing may not be essential, clients retain the flexibility to commission testing services independently. This ensures that regardless of project classification, comprehensive material characterisation and performance validation remain accessible when required for specific warranty or compliance obligations.



U-Value modelling and calculation

Using industry-leading modelling software, our Engineering Team can assist you with your u-value modelling and calculations.

Golden Thread – Gateways 2 and 3

Our comprehensive technical documentation and calculation packages streamline compliance with the Building Safety Act's golden thread gateway requirements, significantly reducing the regulatory burden on designers and contractors working on Higher-Risk Residential Buildings.

By providing complete, digitally-integrated packages that align with Building Safety Regulator (BSR) submission requirements across Gateways 2 and 3, we eliminate the time-consuming process of collating disparate technical information from multiple sources.

This consolidated approach ensures designers can confidently demonstrate regulatory compliance with the detailed plans, specifications, and schedules required by the BSR, whilst contractors benefit from having all necessary as-built documentation, fire and emergency files, and compliance statements readily formatted for gateway submissions.

With nearly 30% of current gateway applications being rejected for insufficient detail or missing information, our integrated approach significantly reduces project delays and the risk of costly resubmissions.

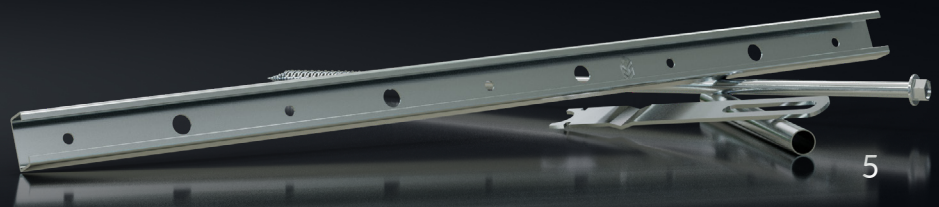

Bi-metal™ Composite Panel Range (LIGHT SECTION)



BMHT12^{*} RANGE

Perfect Choice For Our Brick Tie channel System Through Light Gauge Steel.

TEK 3[®] POINT FOR:

1.2 -4.0mm STEEL THICKNESS

FOR LIGHT STEEL

WITH 12mm WASHER

*FIXTURE BUILD-UP DATA ON PAGE 11



FULL RANGE FROM:
5.5mm-80mm to 350mm

BMHT12-5.5-80-3	BMHT12-5.5-105-3
BMHT12-5.5-135-3	BMHT12-5.5-150-3
BMHT12-5.5-165-3	BMHT12-5.5-185-3
BMHT12-5.5-200-3	BMHT12-5.5-225-3
BMHT12-5.5-235-3	BMHT12-5.5-250-3
BMHT12-5.5-275-3	BMHT12-5.5-300-3
BMHT12-5.5-325-3	BMHT12-5.5-350-3



TM
**Bi-Metal
 Masonry Range**



*
**A4HH
 RANGE**

Perfect Choice
 For Our Brick Tie
 channel System
 Masonry, Concrete &
 Timber Substrates

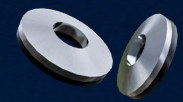

**Epdm 16.0mm
 A4 Stainless
 Steel Bonded
 Washers
 Required**

**FOR
 CONCRETE &
 TIMBER FRAME**

A4 GRADE

FULL RANGE FROM:
 6.3mm-32mm to 275mm/
 8.0mm - 40mm to 350mm

A4HH6.3-32-GP	A4HH6.3-45-GP
A4HH6.3-57-GP	A4HH6.3-70-GP
A4HH6.3-82-GP	A4HH6.3-100-GP
A4HH6.3-125-GP	A4HH6.3-140-GP
A4HH6.3-160-GP	A4HH6.3-180-GP
A4HH6.3-200-GP	A4HH6.3-225-GP
A4HH6.3-250-GP	A4HH8.0-275-GP
A4HH8.0-300-GP	A4HH8.0-350-GP

Tie Lengths



Grade 316 stainless steel is available on request for high corrosion areas.

Wall-Tie SKU	Size
ESCHT-100	100mm
ESCHT-125	125mm
ESCHT-150	150mm
ESCHT-175	175mm
ESCHT-200	200mm
ESCHT-225	225mm
ESCHT-250	250mm
ESCHT-275	275mm
ESCHT-300	300mm
ESCHT-325	325mm
ESCHT-350	350mm
ESCHT-375	375mm

CHANNEL TIE CAVITY KEY	
35-59mm	ESCHT-100
60-84mm	ESCHT-125
85-109mm	ESCHT-150
110-134mm	ESCHT-175
135-159mm	ESCHT-200
160-184mm	ESCHT-225
185-209mm	ESCHT-250
210-234mm	ESCHT-275
235-259mm	ESCHT-300
260-284mm	ESCHT-325
285-309mm	ESCHT-350
310-334mm	ESCHT-375

Recommended Wall Tie and Fixing Screw Vertical Centres, based on 25/14 Channel at 600mm Horizontal Centres

Tie Type	Insulation Thickness (mm)	Vertical Tie Spacing (mm)	Vertical Fixing Spacing (mm)
1	Max 300	300	225/ 337.5*
2	Max 300	450	337.5
3	Max 300	450	337.5/450*
4	Max 300	450	337.5/450*

337.5mm spacings/centres may be used subject to wind load calculations – please contact technical@evofas.com for assistance with calculations.

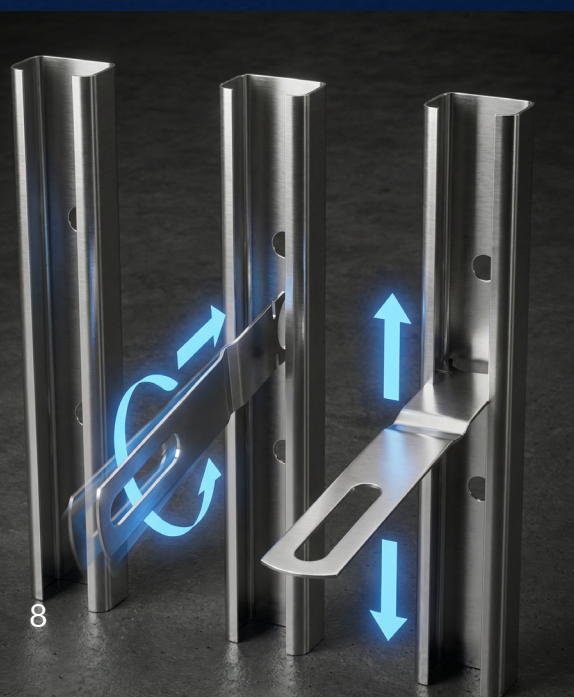

25/14 channel

The channel features fixing holes for stainless steel screws, and ties should be installed at the recommended vertical intervals for the specific system type.

Ensure the correct hole size is used according to the application. Standard lengths are 2700mm.

The 25/14 channel is available in 2700mm lengths and features closely spaced pre-punched holes to ensure a fixing position is always near the end, even when cut on-site.

The channel has a 16mm opening to easily accommodate washers and fixings. The 25/14 channel includes alternating 9.7mm and 5.75mm diameter holes to accept different fixings.

Use the smaller diameter holes for fixing to steel or timber, and the larger diameter holes for concrete fixings.

Grade 316 stainless steel is available on request for high corrosion areas.

Note: Using the incorrect hole and fixing screw combination will compromise system performance and irredeemably invalidate the system warranty.

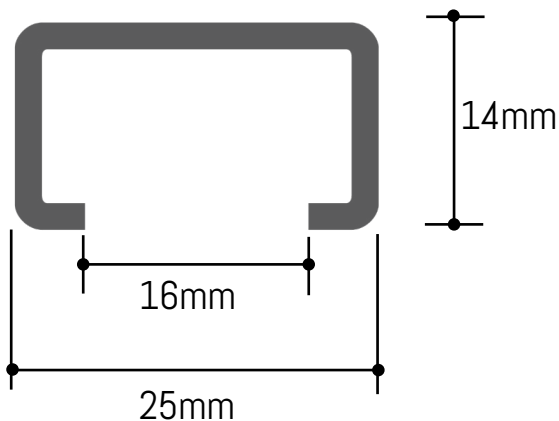

Application Guide

This section details the correct size of stainless-steel compression sleeve to use in conjunction with your application's nominal thickness of insulation as well as the correct fastener to use for such thickness (and a 12.5mm sheathing board).

- The information provided is intended as a quick reference tool only, the designer must satisfy themselves that the solution they choose for any particular application is suitable.
- When in doubt, or where further assistance is required, please seek further advice by e-mailing technical@evofas.com. Not that parts noted with "*" are by special request only to technical@evofas.com.
- A4 stainless-steel variants of fasteners with pancake/ low-profile heads are available upon special request to technical@evofas.com.

Compression Sleeves

Compression sleeves are used to ensure insulation is not adversely compressed, thus reducing u-values.

They are also useful installation aides and help ensure accurate placement of fasteners and maintaining system rigidity.



SKU	Size
SSCS10-50	50mm
SSCS10-60	60mm
SSCS10-75	75mm
SSCS10-80	80mm
SSCS10-90	90mm
SSCS10-100	100mm
SSCS10-110	110mm
SSCS10-120	120mm
SSCS10-125	125mm
SSCS10-130	130mm
SSCS10-135	135mm
SSCS10-140	140mm
SSCS10-150	150mm
SSCS10-160	160mm
SSCS10-170	170mm
SSCS10-175	175mm
SSCS10-180	180mm
SSCS10-190	190mm
SSCS10-200	200mm
SSCS10-220	220mm
SSCS10-230	230mm
SSCS10-240	240mm
SSCS10-250	250mm
SSCS10-260	260mm
SSCS10-270	270mm
SSCS10-280	280mm
SSCS10-290	290mm
SSCS10-300	300mm

Structural Framing System (SFS) substrates:

Compression sleeves are required for certain types of rainscreen insulation 180mm & thicker. For full installation details, please refer to Page 11 of our User Installation Guide.

Concrete Substrates:

A compression sleeve is required for all applications, regardless of insulation thickness.

Where additional bearing surface or improved installation control is required, flanged stainless-steel compression sleeves can be manufactured to project specification upon request.

Light Gauge Mild Steel And Aluminium Sections And Sub-Structures



(1.2mm to 4.0mm Thicknesses)



Washers available in 12/16 mm sizes.

The Enterprise Brick-tie channel system™ is designed to Connect the outer leaf of a cavity wall to a light steel frame through mineral wool using an appropriate fixing.

This system comprises several components that work together to form a robust structural restraint assembly.

For light gauge steel frames, the smaller holes are intended for use with high-thread self-drilling fixings.

All fixings used with the Enterprise Brick-tie channel system™ are made of stainless steel.

At each fixing point, a compression sleeve with high compressive strength ensures a high-capacity fixing detail, accommodating even the thickest insulation used in modern construction.

Fastening Insulation To Light Gauge Mild Steel Or Aluminium Substrates

Application			Fastener Solution		
Insulation Thickness, t_{insul} (mm)	Sheathing Board Thickness, t_{board} (mm)	Substrate Thickness, t_{sub} (mm)	Compression Sleeve	Fastener by Corrosivity	
				C3	C4
≤ 50.0	0.0 ≤ 12.5	1.2 ≤ 4.0	SSCS10-50	BMHT12-5.5-105-3	A4BMHT105-3
≤ 60.0	0.0 ≤ 12.5	1.2 ≤ 4.0	SSCS10-60	BMHT12-5.5-105-3	A4BMHT105-3
≤ 75.0	0.0 ≤ 12.5	1.2 ≤ 4.0	SSCS10-75	BMHT12-5.5-135-3	A4BMHT135-3
≤ 80.0	0.0 ≤ 12.5	1.2 ≤ 4.0	SSCS10-80	BMHT12-5.5-135-3	A4BMHT135-3
≤ 85.0	0.0 ≤ 12.5	1.2 ≤ 4.0	SSCS10-85	BMHT12-5.5-135-3	A4BMHT135-3
≤ 90.0	0.0 ≤ 12.5	1.2 ≤ 4.0	SSCS10-90	BMHT12-5.5-135-3	A4BMHT135-3
≤ 100.0	0.0 ≤ 12.5	1.2 ≤ 4.0	SSCS10-100	BMHT12-5.5-150-3	A4BMHT150-3
≤ 110.0	0.0 ≤ 12.5	1.2 ≤ 4.0	SSCS10-110	BMHT12-5.5-150-3	A4BMHT150-3
≤ 120.0	0.0 ≤ 12.5	1.2 ≤ 4.0	SSCS10-120	BMHT12-5.5-165-3	A4BMHT185-3
≤ 125.0	0.0 ≤ 12.5	1.2 ≤ 4.0	SSCS10-125	BMHT12-5.5-165-3	A4BMHT185-3
≤ 130.0	0.0 ≤ 12.5	1.2 ≤ 4.0	SSCS10-130	BMHT12-5.5-185-3	A4BMHT185-3
≤ 135.0	0.0 ≤ 12.5	1.2 ≤ 4.0	SSCS10-135	BMHT12-5.5-185-3	A4BMHT185-3
≤ 140.0	0.0 ≤ 12.5	1.2 ≤ 4.0	SSCS10-140	BMHT12-5.5-185-3	A4BMHT185-3
≤ 150.0	0.0 ≤ 12.5	1.2 ≤ 4.0	SSCS10-150	BMHT12-5.5-200-3	A4BMHT12-5.5-200-3
≤ 160.0	0.0 ≤ 12.5	1.2 ≤ 4.0	SSCS10-160	BMHT12-5.5-200-3	A4BMHT12-5.5-200-3
≤ 170.0	0.0 ≤ 12.5	1.2 ≤ 4.0	SSCS10-170	BMHT12-5.5-225-3	A4BMHT12-5.5-235-3
≤ 180.0	0.0 ≤ 12.5	1.2 ≤ 4.0	SSCS10-180	BMHT12-5.5-235-3	A4BMHT12-5.5-235-3
≤ 190.0	0.0 ≤ 12.5	1.2 ≤ 4.0	SSCS10-190	BMHT12-5.5-250-3	A4BMHT12-5.5-235-3
≤ 200.0	0.0 ≤ 12.5	1.2 ≤ 4.0	SSCS10-200	BMHT12-5.5-250-3	A4BMHT12-5.5-250-3
≤ 220.0	0.0 ≤ 12.5	1.2 ≤ 4.0	SSCS10-220	BMHT12-5.5-275-3	-
≤ 230.0	0.0 ≤ 12.5	1.2 ≤ 4.0	SSCS10-230	BMHT12-5.5-275-3	-
≤ 240.0	0.0 ≤ 12.5	1.2 ≤ 4.0	SSCS10-240	BMHT12-5.5-300-3	-
≤ 250.0	0.0 ≤ 12.5	1.2 ≤ 4.0	SSCS10-250	BMHT12-5.5-300-3	-
≤ 260.0	0.0 ≤ 12.5	1.2 ≤ 4.0	SSCS10-260	BMHT12-5.5-300-3	-
≤ 270.0	0.0 ≤ 12.5	1.2 ≤ 4.0	SSCS10-270	BMHT12-5.5-325-3	-
≤ 280.0	0.0 ≤ 12.5	1.2 ≤ 4.0	SSCS10-280	BMHT12-5.5-325-3	-
≤ 290.0	0.0 ≤ 12.5	1.2 ≤ 4.0	SSCS10-290	BMHT12-5.5-350-3	-
≤ 300.0	0.0 ≤ 12.5	1.2 ≤ 4.0	SSCS10-300	BMHT12-5.5-350-3	-

Important Note:

When fixing into aluminium a stainless-steel fastener **MUST** be used to avoid electrogalvanic accelerated corrosion.

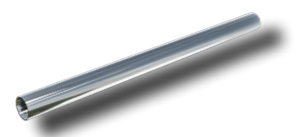

To avoid the negative effects of deformation of the insulation battens, boards and panels, Evolution recommends using a stainless-steel compression sleeve.

For full details on the compression sleeve requirement, please refer to page 11 of our User Installation Guide

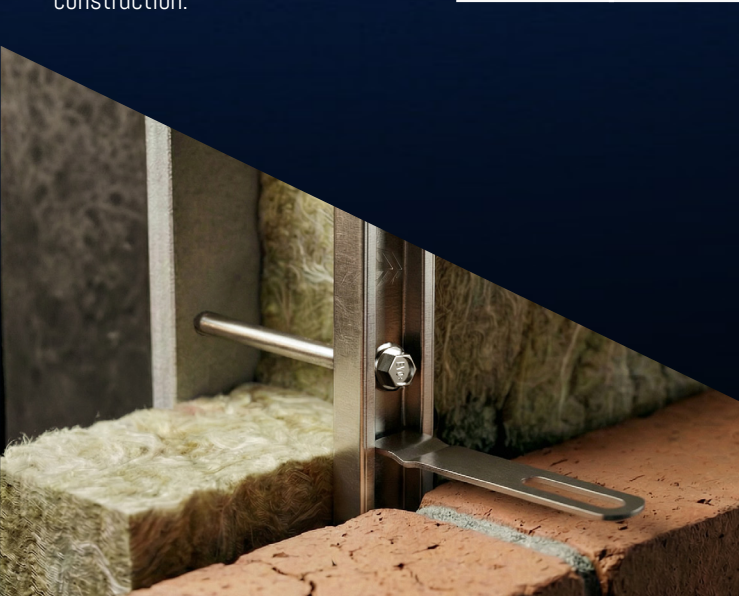

Heavy Gauge Mild Steel And Aluminium Sections And Sub-Structures

Fastening Insulation To Heavy Gauge Mild Steel Or Aluminium Substrates



(4.0mm to 12.0mm thicknesses)

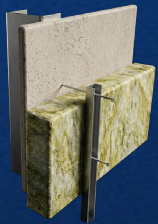

1. OFFER UP CHANNEL TO MATCH SLEEVE LOCATIONS.

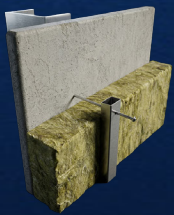

2. INSTALL FIXING THROUGH CHANNEL AND SLEEVE BACK TO INTERNAL STRUCTURE.



3. ROTATE ESCHT WALL TIE INTO CHANNEL LIPS.



4. EMBED TIE INTO MORTAR JOINT.

Application			Fastener Solution		
Insulation Thickness, t_{insul} (mm)	Sheathing Board Thickness, t_{board} (mm)	Substrate Thickness, t_{sub} (mm)	Compression Sleeve	Fastener by Corrosivity	
				C3	C4
≤ 50.0	0.0 ≤ 12.5	4.0 ≤ 12.5	SSCS10-50	BMTSBWHT5.5-125-5	POA
≤ 60.0	0.0 ≤ 12.5	4.0 ≤ 12.5	SSCS10-60	BMTSBWHT5.5-125-5	POA
≤ 70.0	0.0 ≤ 12.5	4.0 ≤ 12.5	SSCS10-75	BMTSBWHT5.5-150-5	POA
≤ 80.0	0.0 ≤ 12.5	4.0 ≤ 12.5	SSCS10-80	BMTSBWHT5.5-150-5	POA
≤ 85.0	0.0 ≤ 12.5	4.0 ≤ 12.5	SSCS10-85	BMTSBWHT5.5-150-5	POA
≤ 90.0	0.0 ≤ 12.5	4.0 ≤ 12.5	SSCS10-90	BMTSBWHT5.5-150-5	POA
≤ 100.0	0.0 ≤ 12.5	4.0 ≤ 12.5	SSCS10-100	BMTSBWHT5.5-185-5	A4BMHT16-5.5-185-7
≤ 110.0	0.0 ≤ 12.5	4.0 ≤ 12.5	SSCS10-110	BMTSBWHT5.5-185-5	A4BMHT16-5.5-185-7
≤ 120.0	0.0 ≤ 12.5	4.0 ≤ 12.5	SSCS10-120	BMTSBWHT5.5-185-5	POA
≤ 125.0	0.0 ≤ 12.5	4.0 ≤ 12.5	SSCS10-125	BMTSBWHT5.5-185-5	POA
≤ 130.0	0.0 ≤ 12.5	4.0 ≤ 12.5	SSCS10-130	POA	POA
≤ 135.0	0.0 ≤ 12.5	4.0 ≤ 12.5	SSCS10-135	POA	POA
≤ 140.0	0.0 ≤ 12.5	4.0 ≤ 12.5	SSCS10-140	POA	A4BMHT16-5.5-235-7
≤ 150.0	0.0 ≤ 12.5	4.0 ≤ 12.5	SSCS10-150	POA	A4BMHT16-5.5-235-7
≤ 160.0	0.0 ≤ 12.5	4.0 ≤ 12.5	SSCS10-160	BMTSBWHT5.5-245-5	A4BMHT16-5.5-235-7
≤ 170.0	0.0 ≤ 12.5	4.0 ≤ 12.5	SSCS10-170	BMTSBWHT5.5-245-5	A4BMHT16-5.5-250-7
≤ 180.0	0.0 ≤ 12.5	4.0 ≤ 12.5	SSCS10-180	BMTSBWHT5.5-245-5	A4BMHT16-5.5-275-7
≤ 190.0	0.0 ≤ 12.5	4.0 ≤ 12.5	SSCS10-190	POA	A4BMHT16-5.5-275-7
≤ 200.0	0.0 ≤ 12.5	4.0 ≤ 12.5	SSCS10-200	POA	A4BMHT16-5.5-275-7
≤ 220.0	0.0 ≤ 12.5	4.0 ≤ 12.5	SSCS10-210	POA	A4BMHT16-5.5-300-7
≤ 230.0	0.0 ≤ 12.5	4.0 ≤ 12.5	SSCS10-230	POA	POA
≤ 240.0	0.0 ≤ 12.5	4.0 ≤ 12.5	SSCS10-240	POA	POA
≤ 250.0	0.0 ≤ 12.5	4.0 ≤ 12.5	SSCS10-250	POA	POA

*Re-washing available on request.

The Enterprise Brick-tie channel system™ is designed to connect the outer leaf of a cavity wall to a heavy steel frame through mineral wool using an appropriate fixing.

This system comprises several components that work together to form a robust structural restraint assembly.

For heavy gauge steel frames, the smaller holes are intended for use with high-thread self-drilling fixings, made for heavy steel.

Masonry, Concrete & Timber Substrates

Fastening Insulation To Concrete and Timber Substrates

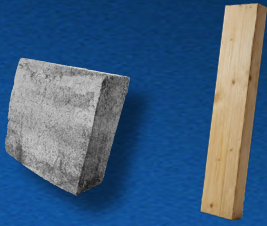

A Stainless Steel Compression Sleeve, The Same Depth As The Insulation, Is Required And The Screw Is Installed Through The Channel And The Compression Sleeve, Located In The Insulation, And Into The Pilot Hole In The Concrete Frame.

To avoid the negative effects of deformation of the insulation battens, boards and panels, Evolution recommends using a stainless-steel compression sleeve.

For full details on the compression sleeve requirement, please refer to page 11 of our User Installation Guide

Application			Fastener Solution		
Insulation Thickness, t_{insul} (mm)	Sheathing Board Thickness, t_{board} (mm)	Embedment Depth t_{sub} (mm)	Compression Sleeve	Fastener by Corrosivity	
				C3	C4
≤ 50.0	0.0 ≤ 12.5	≥ 25.0 ≤ 45.0	SSCS10-50	A4HH6.3-100-GP	A4HH6.3-100-GP
≤ 60.0	0.0 ≤ 12.5	≥ 25.0 ≤ 45.0	SSCS10-60	A4HH6.3-125-GP	A4HH6.3-125-GP
≤ 75.0	0.0 ≤ 12.5	≥ 25.0 ≤ 45.0	SSCS10-75	A4HH6.3-140-GP	A4HH6.3-140-GP
≤ 80.0	0.0 ≤ 12.5	≥ 25.0 ≤ 45.0	SSCS10-80	A4HH6.3-140-GP	A4HH6.3-140-GP
≤ 85.0	0.0 ≤ 12.5	≥ 25.0 ≤ 45.0	SSCS10-85	A4HH6.3-160-GP	A4HH6.3-160-GP
≤ 90.0	0.0 ≤ 12.5	≥ 25.0 ≤ 45.0	SSCS10-90	A4HH6.3-160-GP	A4HH6.3-160-GP
≤ 100.0	0.0 ≤ 12.5	≥ 25.0 ≤ 45.0	SSCS10-100	A4HH6.3-160-GP	A4HH6.3-160-GP
≤ 110.0	0.0 ≤ 12.5	≥ 25.0 ≤ 45.0	SSCS10-110	A4HH6.3-180-GP	A4HH6.3-180-GP
≤ 120.0	0.0 ≤ 12.5	≥ 25.0 ≤ 45.0	SSCS10-120	A4HH6.3-180-GP	A4HH6.3-180-GP
≤ 125.0	0.0 ≤ 12.5	≥ 25.0 ≤ 45.0	SSCS10-125	A4HH6.3-180-GP	A4HH6.3-180-GP
≤ 130.0	0.0 ≤ 12.5	≥ 25.0 ≤ 45.0	SSCS10-130	A4HH6.3-200-GP	A4HH6.3-200-GP
≤ 135.0	0.0 ≤ 12.5	≥ 25.0 ≤ 45.0	SSCS10-135	A4HH6.3-200-GP	A4HH6.3-200-GP
≤ 140.0	0.0 ≤ 12.5	≥ 25.0 ≤ 45.0	SSCS10-140	A4HH6.3-200-GP	A4HH6.3-200-GP
≤ 150.0	0.0 ≤ 12.5	≥ 25.0 ≤ 45.0	SSCS10-150	A4HH6.3-200-GP	A4HH6.3-200-GP
≤ 160.0	0.0 ≤ 12.5	≥ 25.0 ≤ 45.0	SSCS10-160	A4HH6.3-200-GP	A4HH6.3-200-GP
≤ 170.0	0.0 ≤ 12.5	≥ 25.0 ≤ 45.0	SSCS10-170	A4HH6.3-250-GP	A4HH6.3-250-GP
≤ 180.0	0.0 ≤ 12.5	≥ 25.0 ≤ 45.0	SSCS10-180	A4HH6.3-250-GP	A4HH6.3-250-GP
≤ 190.0	0.0 ≤ 12.5	≥ 25.0 ≤ 45.0	SSCS10-190	A4HH6.3-250-GP	A4HH6.3-250-GP
≤ 200.0	0.0 ≤ 12.5	≥ 25.0 ≤ 45.0	SSCS10-200	A4HH6.3-250-GP	A4HH6.3-250-GP
≤ 220.0	0.0 ≤ 12.5	≥ 25.0 ≤ 45.0	SSCS10-220	A4HH8.0-275-GP	A4HH8.0-275-GP
≤ 230.0	0.0 ≤ 12.5	≥ 25.0 ≤ 45.0	SSCS10-230	A4HH8.0-275-GP	A4HH8.0-275-GP
≤ 240.0	0.0 ≤ 12.5	≥ 25.0 ≤ 45.0	SSCS10-240	A4HH8.0-275-GP	A4HH8.0-275-GP
≤ 250.0	0.0 ≤ 12.5	≥ 25.0 ≤ 45.0	SSCS10-250	A4HH8.0-300-GP	A4HH8.0-300-GP
≤ 260.0	0.0 ≤ 12.5	≥ 25.0 ≤ 45.0	SSCS10-260	A4HH8.0-300-GP	A4HH8.0-300-GP
≤ 270.0	0.0 ≤ 12.5	≥ 25.0 ≤ 45.0	SSCS10-270	A4HH8.0-350-GP	A4HH8.0-350-GP
≤ 280.0	0.0 ≤ 12.5	≥ 25.0 ≤ 45.0	SSCS10-280	A4HH8.0-350-GP	A4HH8.0-350-GP
≤ 290.0	0.0 ≤ 12.5	≥ 25.0 ≤ 45.0	SSCS10-290	A4HH8.0-350-GP	A4HH8.0-350-GP
≤ 300.0	0.0 ≤ 12.5	≥ 25.0 ≤ 45.0	SSCS10-300	A4HH8.0-350-GP	A4HH8.0-350-GP

CONCRETE



1. DRILL PILOT HOLE (SEE TABLE ON NEXT PAGE).

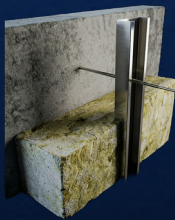

2. INSTALL FIXING THROUGH CHANNEL AND SLEEVE BACK TO INTERNAL STRUCTURE.



3. ROTATE ESCHT WALL TIE INTO CHANNEL LIPS.



4. EMBED TIE INTO MOTAR JOINT

TIMBER



The Enterprise Brick-tie channel system™ is designed to connect an outer leaf of a masonry cavity wall to a concrete frame or another structural element through mineral wool using an appropriate fixing. This system comprises several components that work together to form a robust structural restraint assembly.

It features numerous pre-punched holes spaced closely together, allowing for flexible fixing points based on the application. For concrete applications, the larger holes are intended for use with stainless steel masonry fixings.

At each fixing point, a compression sleeve with high compressive strength ensures a high-capacity fixing detail, accommodating even the thickest insulation used in modern construction.

Primary Fixings & Technical Data by Substrate Type

Light Steel • Heavy Steel • Concrete

BMHT12



FOR LIGHT STEEL

CHARACTERISTIC WITHDRAWAL RESISTANCE, N_{Rk} (N)								
Fastener Properties		Substrate Grade	Substrate Nominal Thickness, t_{sub} (mm)					
MATERIAL	NOM DIA. d_{nom}		1.20	1.60	2.00	2.50	3.00	4.00
EN 1.4301/ EN 1.4401	5.50	S320GD	1,700	2,100	2,500	3,300	4,100	5,400
EN 1.4301/ EN 1.4401	5.50	S450JR	2,300	2,900	3,500	4,600	5,700	7,500

CHARACTERISTIC MECHANICAL PROPERTIES (N)	
CHARACTERISTIC	MAGNITUDE
Tensile capacity, $F_{u,Rk}$	13,300
Shearing resistance, $V_{u,Rk}$	7,900

CHARACTERISTIC PULL-OVER RESISTANCE, $N_{Rk,WASHER}$ (N)	
WASHER DIAMETER, d_{washer}	MAGNITUDE
12.0	8,100
16.0	8,400

BMTSBWHT



FOR HEAVY STEEL

CHARACTERISTIC WITHDRAWAL RESISTANCE, N_{Rk} (N)								
Fastener Properties		Substrate Grade	Substrate Nominal Thickness, t_{sub} (mm)					
MATERIAL	NOM DIA. d_{nom}		4.00	5.00	6.00	8.00	10.00	12.00
EN 1.4301	5.50	S320GD	6,400	7,700	10,100	11,400	12,300	13,300
EN 1.4301	5.50	S450JR	8,300	10,000	12,800	13,300	13,300	13,300

CHARACTERISTIC MECHANICAL PROPERTIES (N)	
CHARACTERISTIC	MAGNITUDE
Tensile capacity, $F_{u,Rk}$	13,300
Shearing resistance, $V_{u,Rk}$	7,900

CHARACTERISTIC PULL-OVER RESISTANCE, $N_{Rk,WASHER}$ (N)	
WASHER DIAMETER, d_{washer}	MAGNITUDE
12.0	8,100
16.0	8,400

6.3 Dia



A4HH

FOR CONCRETE

CHARACTERISTIC WITHDRAWAL RESISTANCE, N_{Rk} (N)			
Embedment Depth, t_{sub} (mm)	Substrate Type		
	CONCRETE (35 MPa)	BLOCK (7 MPa)	BRICK (75 MPa)
25.0	3,900	2,700	4,200
40.0	5,700	3,900	5,900

CHARACTERISTIC PULL-OVER RESISTANCE, $N_{Rk,WASHER}$ (N)	
WASHER DIAMETER, d_{washer}	MAGNITUDE
16.0	8,400

CHARACTERISTIC MECHANICAL PROPERTIES (N)	
CHARACTERISTIC	MAGNITUDE
Tensile capacity, $F_{u,Rk}$	14,100
Shearing resistance, $V_{u,Rk}$	8,500

8.0 Dia

CHARACTERISTIC WITHDRAWAL RESISTANCE, N_{Rk} (N)	
Embedment Depth, t_{sub} (mm)	C35 Concrete (35N/mm ²)
35.0	6,400 N
45.0	8,400 N

CHARACTERISTIC MECHANICAL PROPERTIES (N)	
CHARACTERISTIC	MAGNITUDE
Tensile capacity, $F_{u,Rk}$	32,100
Shearing resistance, $V_{u,Rk}$	20,100
Torsional Capacity, $T_{u,Rk}$	>25Nm

Evolution provides a wide range of fastener options which vary depending on the critical contributing factor of substrate thickness.

Enterprise is not just a brick tie system.

It's a fully supported technical solution, designed to reduce risk, simplify approvals, and stand up to scrutiny at every stage of a project.

Fully Stainless Steel System

The Enterprise range is manufactured in stainless steel to deliver long-term durability, corrosion resistance and performance across exposure classes.

Wind Load Calculations

Project-specific wind load calculations are provided to determine correct tie type, density and spacing, ensuring compliance with relevant standards and site conditions.

Site Inspections & Toolbox Talks

On-site technical support can be provided to verify correct installation and offer guidance to site teams, helping ensure best practice and compliance.

Established Technical Process

Enterprise is supported by a structured technical workflow, from design consultation to installation guidance, ensuring consistency and accountability.



Bi-metal™ Composite Panel Range

(LIGHT SECTION) BMTSBWHT

FOR LIGHT STEEL	WITH 16mm WASHER		FULL RANGE FROM: 5.5mm- 80mm to 300mm
BMTSBWHT5.5-80-3	BMTSBWHT5.5-105-3	BMTSBWHT5.5-115-3	BMTSBWHT5.5-135-3
BMTSBWHT5.5-150-3	BMTSBWHT5.5-165-3	BMTSBWHT5.5-185-3	BMTSBWHT5.5-200-3
BMTSBWHT5.5-225-3	BMTSBWHT5.5-235-3	BMTSBWHT5.5-300-3	

Bi-metal™ Composite Panel Range

(LIGHT SECTION) A4BMHT

FOR LIGHT STEEL	WITH *12/16mm WASHER	RANGE FROM 5.5mm - 105mm - 235mm	
A4BMHT105-3	A4BMHT135-3	A4BMHT150-3	A4BMHT185-3
A4BMHT12-5.5-200-3	A4BMHT12-5.5-235-3	A4BMHT12-5.5-250-3	

Bi-metal™ Composite Panel Range (HEAVY SECTION)

BMTSBWHT

	FOR HEAVY STEEL	WITH 12/16mm WASHER	RANGE FROM 5.5mm- 105mm to 245mm
12mm washers	BMTSBWHT12-5.5-185-5		BMTSBWHT12-5.5-245-5
16mm washers	BMTSBWHT5.5-105-5		BMTSBWHT5.5-125-5
	BMTSBWHT5.5-150-5		BMTSBWHT16-5.5-185-5
	BMTSBWHT16-5.5-245-5		

BI-METAL™ SuperTEK® 7 COMPOSITE PANEL RANGE (SUPER-HEAVY SECTION)

A4BMHT16
RANGE

FOR SUPER-HEAVY STEEL	A4 GRADE	RANGE FROM: 6.3mm - 185mm to 300mm
-----------------------------	----------	--

CODE:

A4BMHT16-6.3-185-7*	A4BMHT16-6.3-235-7*
A4BMHT16-6.3-250-7*	A4BMHT16-6.3-275-7*
A4BMHT16-6.3-300-7*	

Especially suited to fixing brick ties, components, bracketry and secondary frame elements/ sections to primary and secondary steel framing where a weather sealing washer is required.

1.06mm (24 TPI) fine thread pitches ensure that maximum positive thread engagement with substrates is achieved.

Note that parts noted with "*" are by special request only to technical@evofas.com.

CHARACTERISTIC WITHDRAWAL RESISTANCE, N_{Rk} (N)

Fastener Properties		SUBSTRATE GRADE	Substrate Nominal Thickness, t_{sub} (mm)					
MATERIAL	NOM DIA. d_{nom}		4.00	5.00	6.00	8.00	10.00	12.00
EN 1.4301	5.50	S320GD	6,400	7,700	10,100	11,400	12,300	13,300
EN 1.4301	5.50	S450JR	8,300	10,000	12,800	13,300	13,300	13,300

CHARACTERISTIC MECHANICAL PROPERTIES (N)

Characteristic	Magnitude
Tensile capacity, $F_{u,Rk}$	13,300
Shearing resistance, $V_{u,Rk}$	7,900

CHARACTERISTIC PULL-OVER RESISTANCE, $N_{Rk,WASHER}$ (N)

WASHER DIAMETER, d_{washer}	MAGNITUDE
16.0	8,400

ON-SITE TESTING

WE BRING THE LAB TO YOUR SITE.



WHAT WE DO ON-SITE



- Pull-out (tension) tests on fixings
- Shear checks where appropriate
- Torque verification and installation audits
- Substrate verification and pilot hole sizing

WHY IT HELPS



- Prove performance in the actual substrate
- Reduce risk, rework and delays
- Faster decisions for site teams
- Documented results for records and sign-off

TYPICAL USE CASES



- Brick tie channels and brackets
- Concrete screws and anchors
- SFS framing and cladding
- Insulation fixings and soffits
- Masonry and timber interfaces

HOW IT WORKS



- Send drawings and a brief, book a visit
- Agree test locations during a site walk-through
- Testing with calibrated equipment
- Immediate guidance on fixing choice and method

WHAT YOU RECEIVE



- On-site results with photos
- Indicative pull-out capacities against the spec
- Recommended fixings and spacings

SAFETY AND QUALITY



- Backed by our UKAS-accredited laboratory
- Equipment calibrated and traceable to national standards

Contact our technical team:

Evolution Laboratory: 0141 737 6556
 Technical Team: 0141 647 7100

Email: technical@evofas.com



T: +44 (0) 141 647 7100
E: sales@evofas.com
E: technical@evofas.com



T: 01922 620333
E: sales@superiorsections.com



T: 01663 749361
E: enquiries@tecties.co.uk

Product Range⁺



www.enterprisesystem.co.uk

© 2026 Evolution Fasteners UK Ltd.
All rights reserved.
All content, including product images,
renders, and graphics, is owned or
licensed by Evolution Fasteners.
Unauthorised use, reproduction, or
distribution is prohibited.